

Catálogo Técnico

Herrero

Herrero/ índice

Detalle	referencia
Corrediza.....	05
Guía cortina.....	10
Tapacinta.....	11
Contravidrios.....	12
Paño fijo central.....	13
Ventiluz y banderola.....	14
Postigón de rebatir.....	15
Puerta bisagra encolizada.....	17
Puerta línea Rosario.....	19
Puerta línea Santa Fe.....	20
Puerta tableto tubular.....	21
Puerta pesada de rebatir y vaivén.....	23
Puerta A25.....	25
Puerta placa.....	26
Marco regulable para puerta placa.....	27
Acoples.....	28
Premarcos.....	30
Vidrio repartido.....	31
Varios.....	32

Prohibida la modificación, publicación o venta, total o parcial de estos documentos, sin la previa autorización por parte de Aluar División Elaborados. Aluar División Elaborados en ningún caso será responsable por los deficientes trabajos ejecutados por terceros en aberturas armadas con nuestros perfiles. Será de exclusiva responsabilidad del instalador, proyectista y/o contratista la previa y correcta verificación estructural de acuerdo a la zona de colocación, exposición y presión de viento, y verificación del balance térmico teniendo en cuenta el tipo de vidrio a utilizar, la temperatura exterior, interior, la humedad relativa, tipo de calefacción, etc.

La empresa se reserva el derecho de modificar total o parcialmente las especificaciones contenidas en este catálogo sin previo aviso.

Este catálogo fue actualizado en julio de 2016.

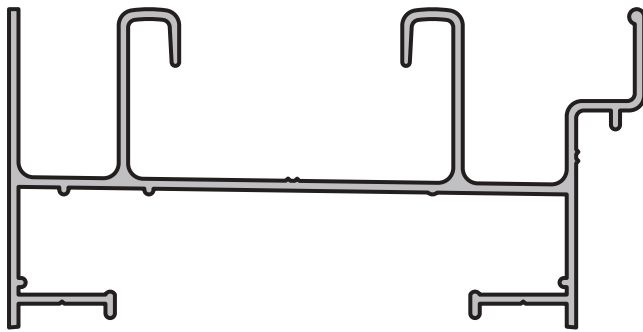

MARCO - VENTANA Y PUERTA CORREDIZA

Perfil: 1
Peso: 0,921 Kg/m
Matriz: M0667

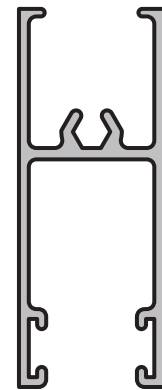

ZOCALO Y CABEZAL - HOJA CORREDIZA

Perfil: 2
Peso: 0,521 Kg/m
Matriz: M0668

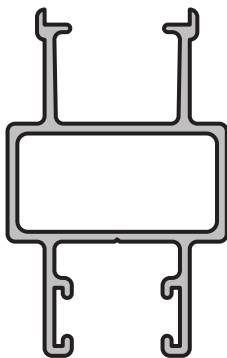

PARANTE LATERAL - HOJA CORREDIZA

Perfil: 3
Peso: 0,577 Kg/m
Matriz: M0669

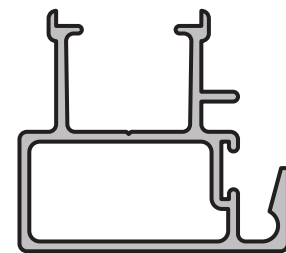

PARANTE CENTRAL - HOJA CORREDIZA

Perfil: 4
Peso: 0,518 Kg/m
Matriz: M0670

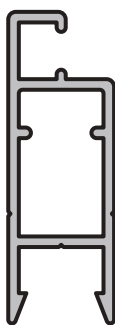

MOSQUITERO

Perfil: 5
Peso: 0,392 Kg/m
Matriz: M0671

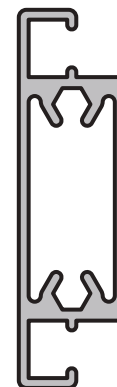

TRAVESAÑO - MOSQUITERO

Perfil: 90
Peso: 0,550 Kg/m
Matriz: M1294

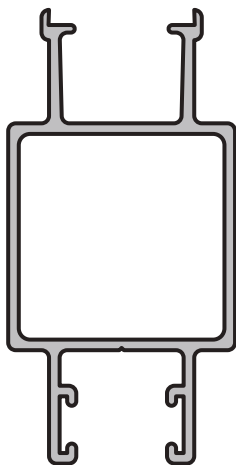

PARANTE LATERAL REFORZADO HOJA

Perfil: 53
Peso: 0,712 Kg/m
Matriz: M0948

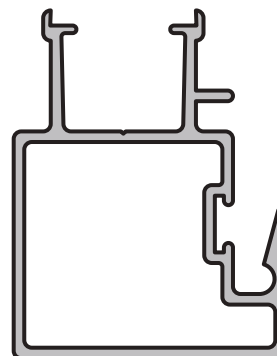

PARANTE CENTRAL REFORZADO HOJA

Perfil: 54
Peso: 0,729 Kg/m
Matriz: M0949

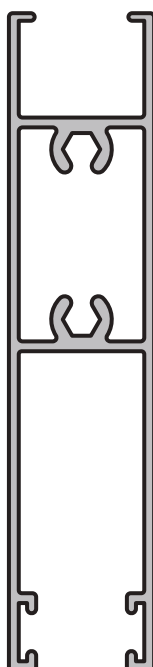

**TRAVESAÑO HOJA
PUERTA CORREDIZA**

Perfil: 224
Peso: 0,915 Kg/m
Matriz: M2741

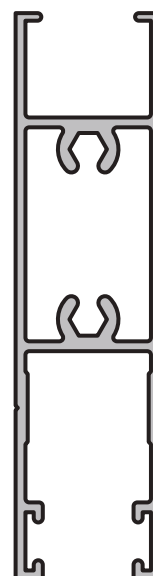

**ZOCALO ALTO
PUERTA CORREDIZA**

Perfil: 44
Peso: 0,848 Kg/m
Matriz: M0843

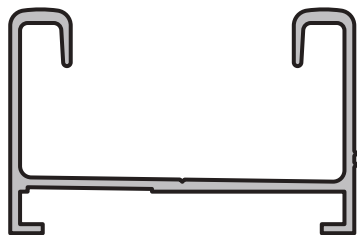

GUIA CON ESCUADRA PARA CORREDIZA

Perfil: 690

Peso: 0,489 Kg/m

Matriz: M1861

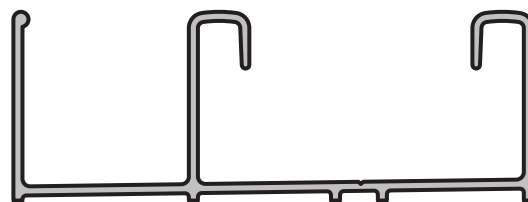

GUIA CORREDIZA CON MOSQUITERO

Perfil: 6568

Peso: 0,540 Kg/m

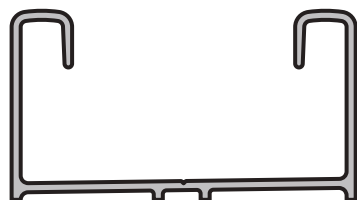

GUIA CORREDIZA SIMPLE

Perfil: 6567

Peso: 0,383 Kg/m

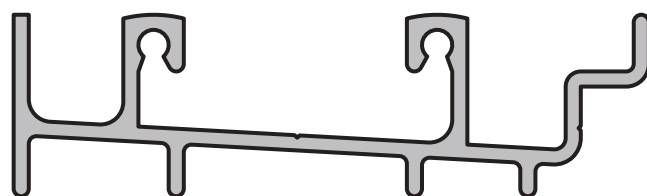

UMBRAL - PUERTA CORREDIZA

Perfil: 17

Peso: 1,050 Kg/m

Matriz: M0688

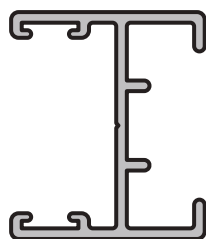

CIERRE CENTRAL - PUERTA Y VENTANA CORREDIZA 4 HOJAS

Perfil: 19

Peso: 0,389 Kg/m

Matriz: M0686

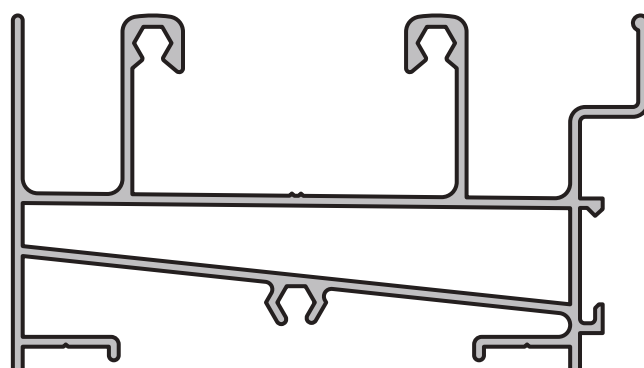

UMBRAL CON CAJA DE AGUA CORREDIZA

Perfil: 219

Peso: 1,369 Kg/m

Matriz: M2677

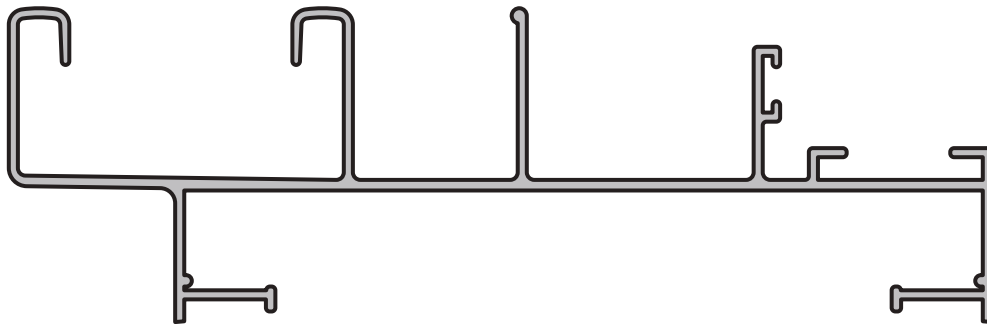

MARCO UNIFICADO CON POSTIGON DE REBATIR

Perfil: 6575

Peso: 1,145 Kg/m

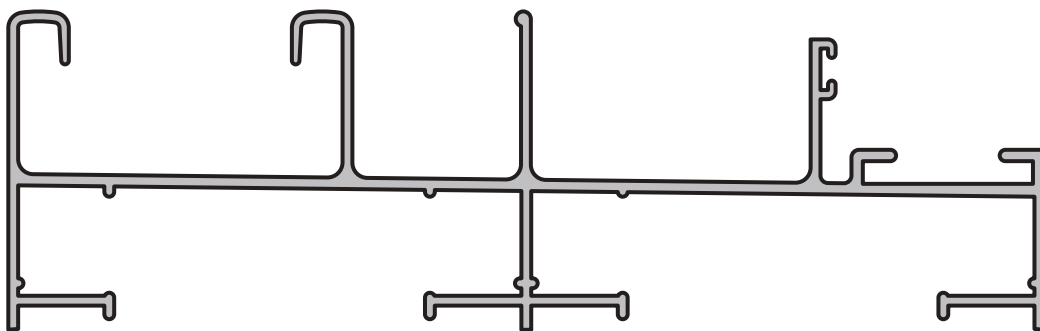

MARCO UNIFICADO CON POSTIGON DE REBATIR

Perfil: 6348

Peso: 1,450 Kg/m

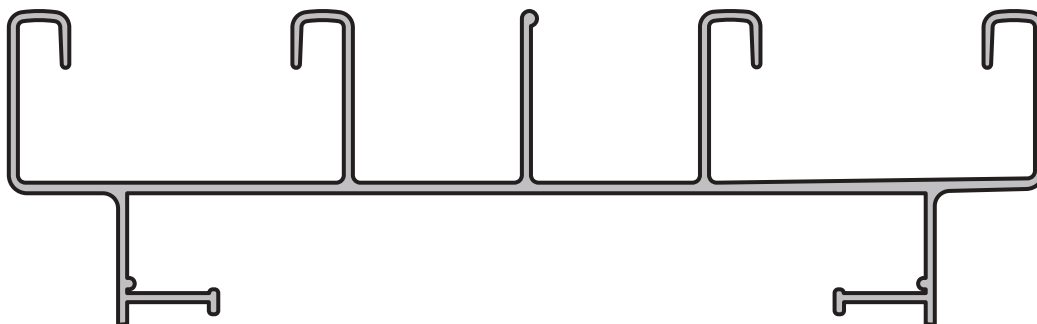

MARCO UNIFICADO CON POSTIGON CORREDIZO

Perfil: 6669

Peso: 1,266 Kg/m

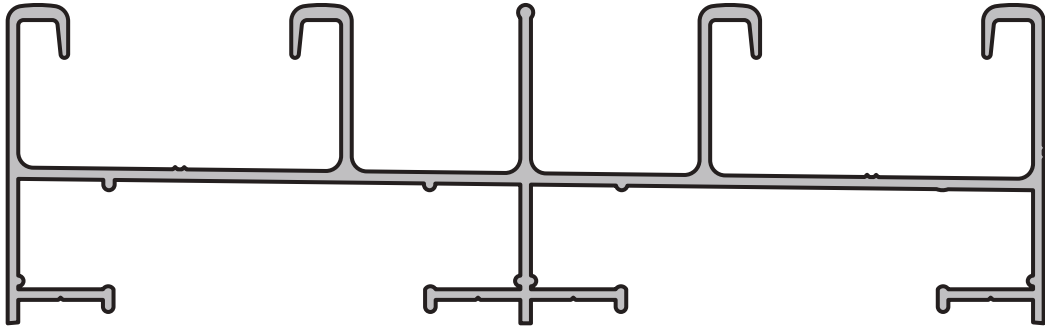

MARCO UNIFICADO CON POSTIGON CORREDIZO

Perfil: 714

Peso: 1,588 Kg/m

Matriz: M2247

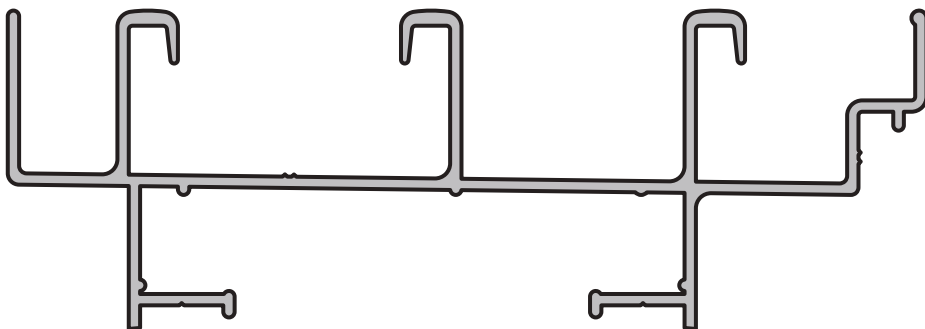

MARCO CORREDIZA DE 3 GUIAS

Perfil: 691

Peso: 1,380 Kg/m

Matriz: M1862



GUIA DE CORTINA BARRIOS

Perfil: 21

Peso: 0,926 Kg/m

Matriz: M0690

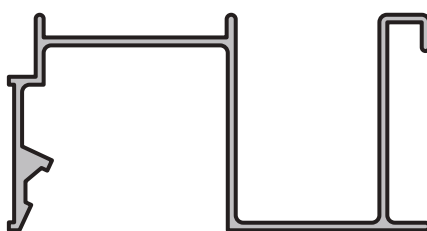

GUIA CORTINA DE ENROLLAR

Perfil: 920

Peso: 0,456 Kg/m

Matriz: M2355



TAPACINTA

Perfil: 521

Peso: 0,427 Kg/m

Matriz: M1985



COMPLEMENTO TAPACINTA

Perfil: 715

Peso: 0,516 Kg/m

Matriz: M2408



**CONTRAVIDRIO UNIVERSAL
PARA MASILLA**

Perfil: 38
Peso: 0,156 Kg/m
Matriz: M0715



CONTRAVIDRIO 6 mm.

Perfil: 78
Peso: 0,151 Kg/m
Matriz: M1035

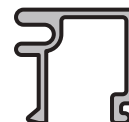

CONTRAVIDRIO

Perfil: 8
Peso: 0,160 Kg/m
Matriz: M0674

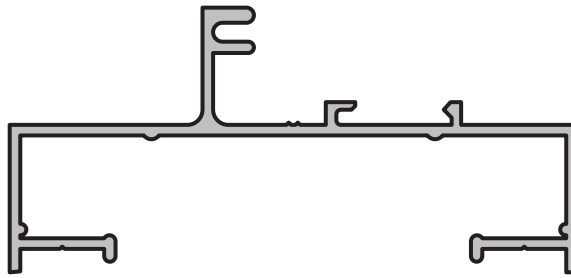

MARCO - PAÑO FIJO

Perfil: 7

Peso: 0,683 Kg/m

Matriz: M0673

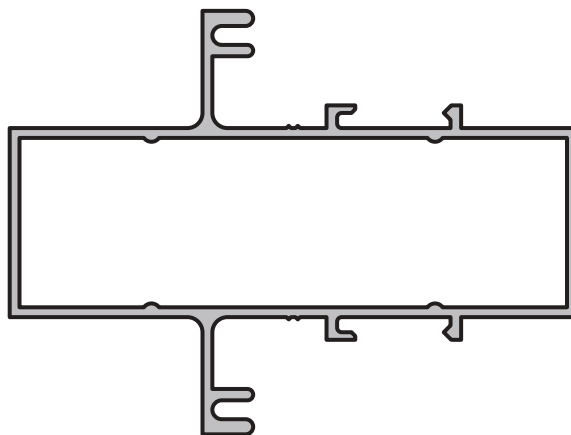

TRAVESAÑO - PAÑO FIJO

Perfil: 94

Peso: 0,975 Kg/m

Matriz: M1366

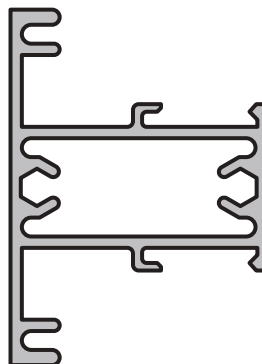

TRAVESAÑO CHICO - PAÑO FIJO

Perfil: 687

Peso: 0,745 Kg/m

Matriz: M1777

Herrero / ventiluz y banderola

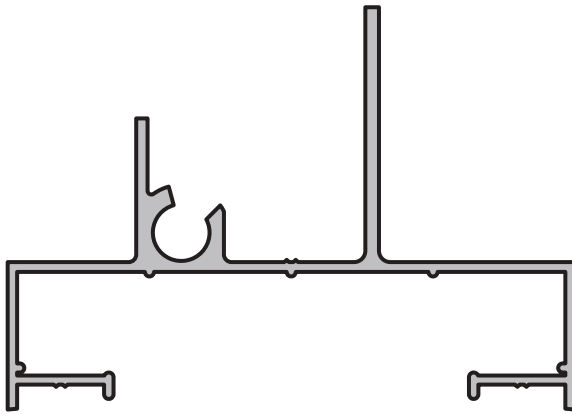

MARCO

Perfil: 216
Peso: 0,826 Kg/m
Matriz: M2705

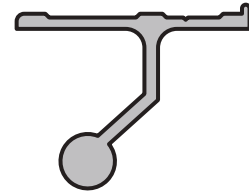

BISAGRA

Perfil: 215
Peso: 0,338 Kg/m
Matriz: M2704

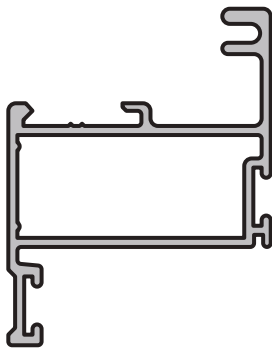

HOJA BANDEROLA

Perfil: 217
Peso: 0,548 Kg/m
Matriz: M2706

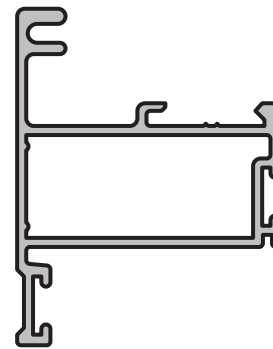

HOJA VENTILUZ

Perfil: 218
Peso: 0,548 Kg/m
Matriz: M2707

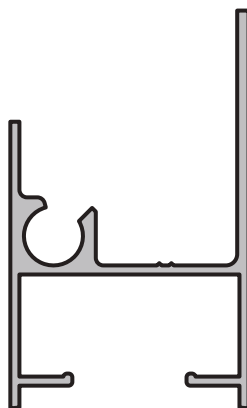

MARCO 31,5 mm.

Perfil: 6565
Peso: 0,556 Kg/m
Matriz: P6565

Herrero / postigón de rebatir

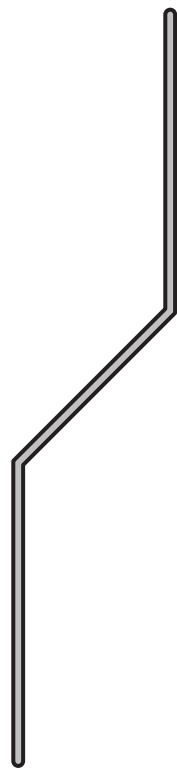

TABLILLA POSTIGON 100 mm.
 Perfil: 127
 Peso: 0,375 Kg/m
 Matriz: M1754

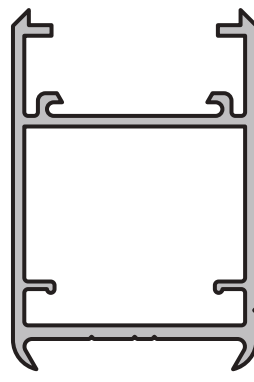

BATIENTE DE HOJA
 Perfil: 174
 Peso: 0,713 Kg/m
 Matriz: M2260

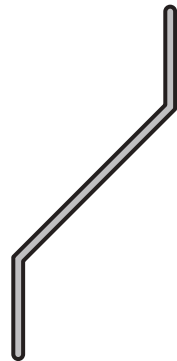

TABLILLA POSTIGON DE 46,6 mm.
 Perfil: 153
 Peso: 0,186 Kg/m
 Matriz: M2009



DISTANCIADOR DE TABLILLA
 Perfil: 126
 Peso: 0,138 Kg/m
 Matriz: M1760

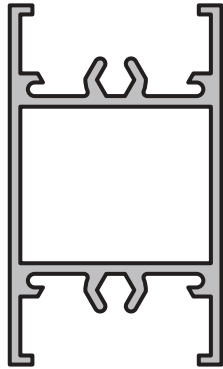

TRAVESAÑO DE HOJA

Perfil: 173

Peso: 0,710 Kg/m

Matriz: M2259

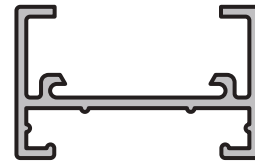

SOPORTE TABLILLA DE POSTIGON

Perfil: 148

Peso: 0,340 Kg/m

Matriz: M1986



TABLILLA POSTIGON

Perfil: 5800

Peso: 0,270 Kg/m

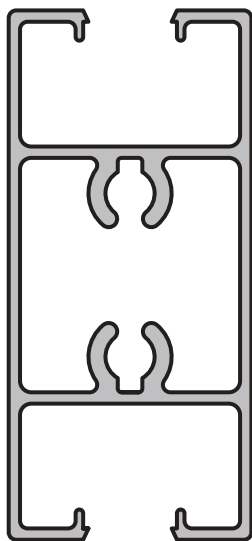

TRAVESAÑO DE HOJA

Perfil: 510
Peso: 1,246 Kg/m
Matriz: M1545

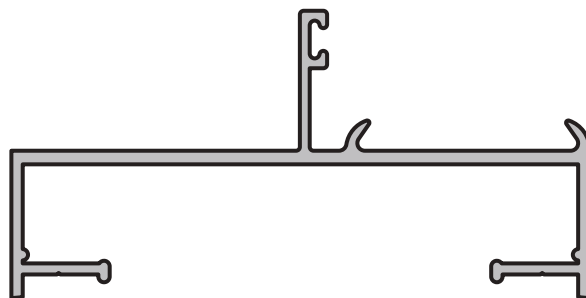

MARCO

Perfil: 524
Peso: 0,745 Kg/m
Matriz: M2333



CONTRAVIDRIO INTERNO

Perfil: 507
Peso: 0,108 Kg/m
Matriz: M1540

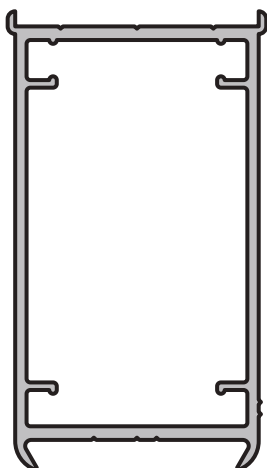

BATIENTE DE HOJA

Perfil: 509
Peso: 0,821 Kg/m
Matriz: M1544



TRAVESAÑO INTERMEDIO

Perfil: 527
Peso: 0,586 Kg/m
Matriz: M2348

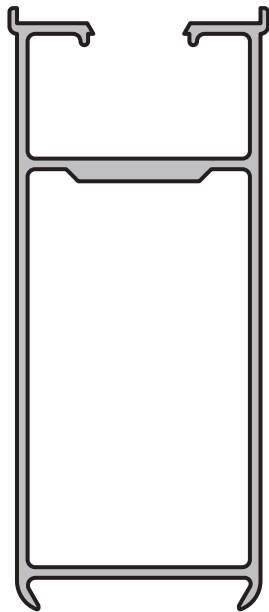

BATIENTE SIN CONTRAVIDRIOS

Perfil: 6350

Peso: 0,977 Kg/m



TAPACANTO

Perfil: 511

Peso: 0,124 Kg/m

Matriz: M1546

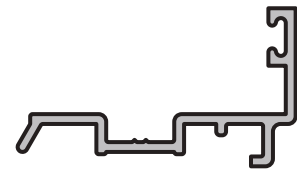

TAPACANTO CON TOPE

Perfil: 519

Peso: 0,262 Kg/m

Matriz: M1909

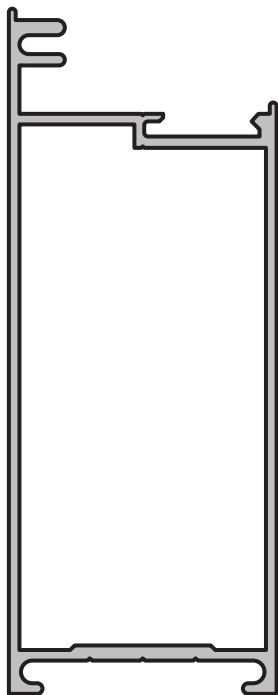

PARANTE ANCHO

Perfil: M-2499
Peso: 1,015 Kg/m
Matriz: M2499

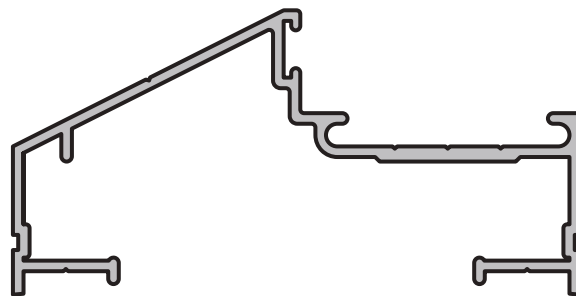

MARCOS

Perfil: M-2473
Peso: 0,724 Kg/m
Matriz: M2473

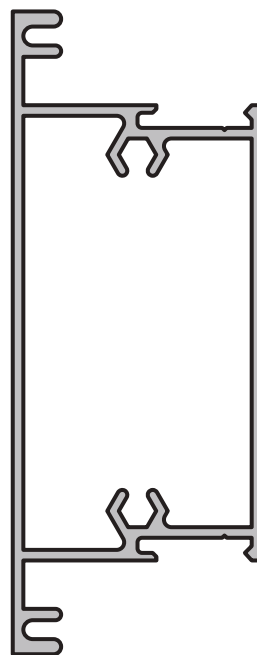

TRAVESAÑO ANCHO

Perfil: M-2212
Peso: 1,010 Kg/m
Matriz: M2212

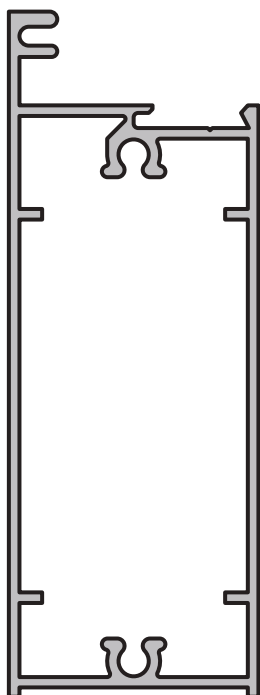

ZOCALO Y CABEZAL ANCHO

Perfil: M-2213
Peso: 1,107 Kg/m
Matriz: M2213



DOBLE CONTACTO

Perfil: M-2471
Peso: 0,200 Kg/m
Matriz: M2471

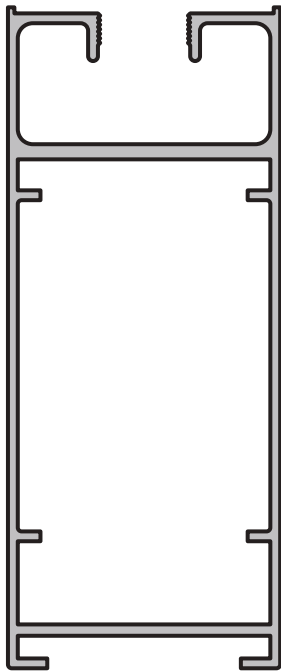

PARANTE

Perfil: 3938

Peso: 1,120 Kg/m

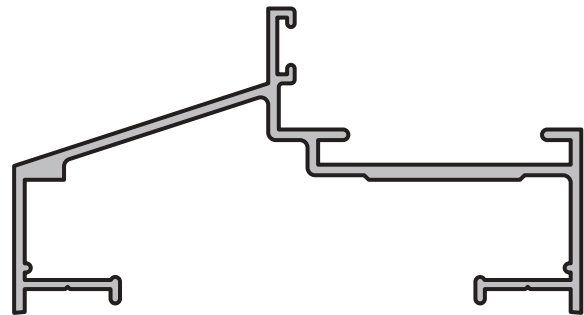

MARCO

Perfil: 3939

Peso: 0,715 Kg/m

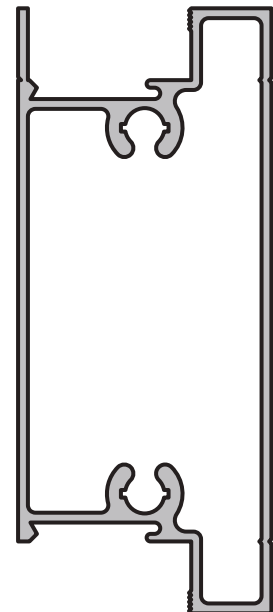

TRAVESAÑO/ ZOCALO/ CABEZAL HOJA

Perfil: 3941

Peso: 1,039 Kg/m

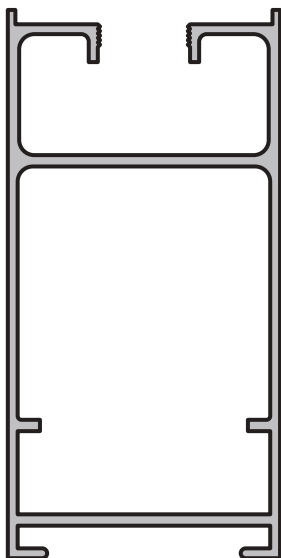

PARANTE MEDIANO

Perfil: 3792

Peso: 0,961 Kg/m

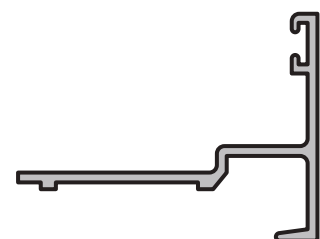

DOBLE CONTACTO

Perfil: 3940

Peso: 0,284 Kg/m

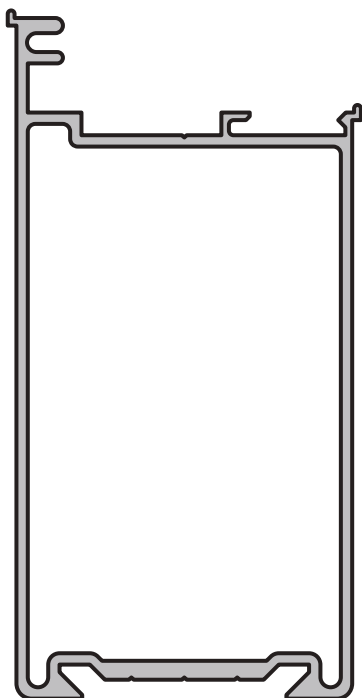

BATIENTE DE HOJA

Perfil: 213
Peso: 1,226 Kg/m
Matriz: M2701

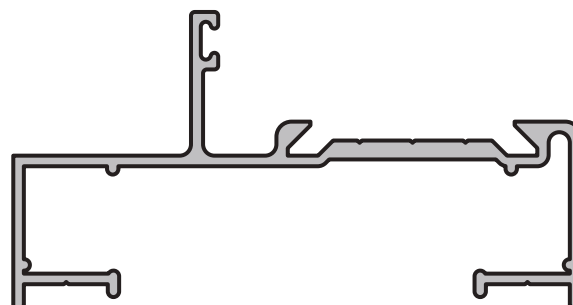

MARCO

Perfil: 211
Peso: 0,780 Kg/m
Matriz: M2699

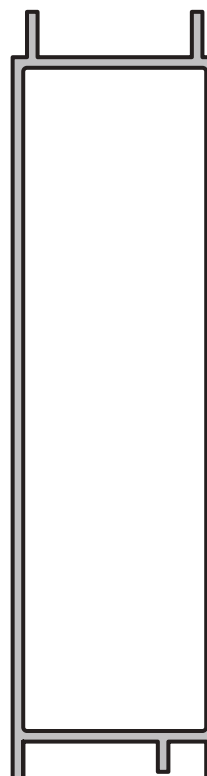

TABLILLA

Perfil: 207
Peso: 0,967 Kg/m
Matriz: M2695

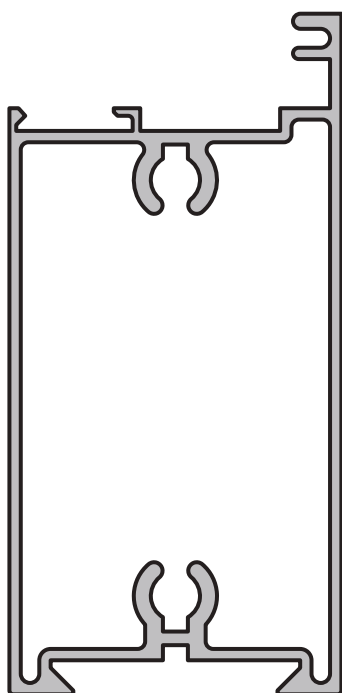

TRAVESAÑO SUPERIOR E INFERIOR

Perfil: 212
Peso: 1,436 Kg/m
Matriz: M2700

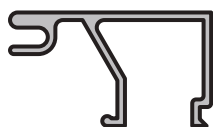

CONTRAVIDRIO

Perfil: 205

Peso: 0,199 Kg/m

Matriz: M2693



CONTRAVIDRIO

Perfil: 206

Peso: 0,119 Kg/m

Matriz: M2694

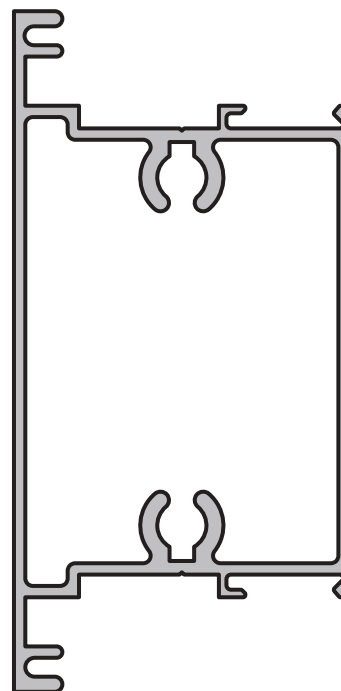

TRAVESAÑO INTERMEDIO

Perfil: 208

Peso: 1,369 Kg/m

Matriz: M2696

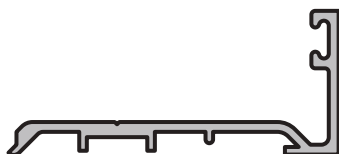

TAPACANTO CENTRAL HOJA

Perfil: 214

Peso: 0,275 Kg/m

Matriz: M2702

Herrero / puerta pesada de rebatir y vaivén

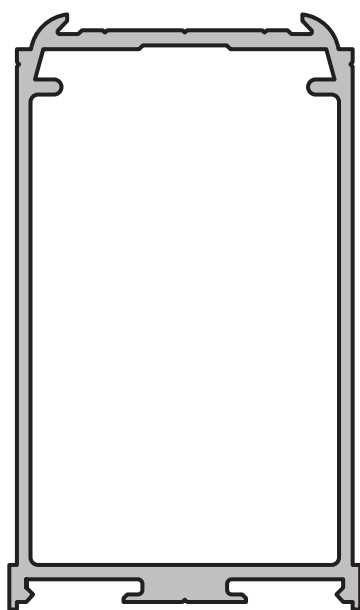

PARANTE HOJA

Perfil: 39
Peso: 1,364 Kg/m
Matriz: M0796

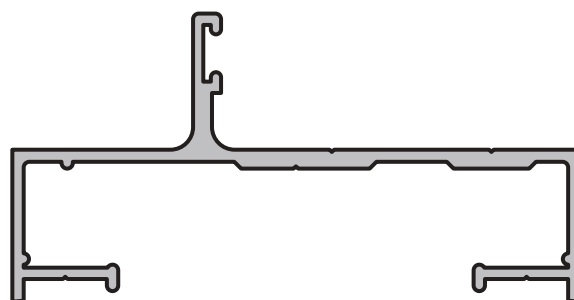

MARCO

Perfil: 10
Peso: 0,788 Kg/m
Matriz: M0676



MARCO - PUERTA VAIVEN

Perfil: 24
Peso: 0,730 Kg/m
Matriz: M0693

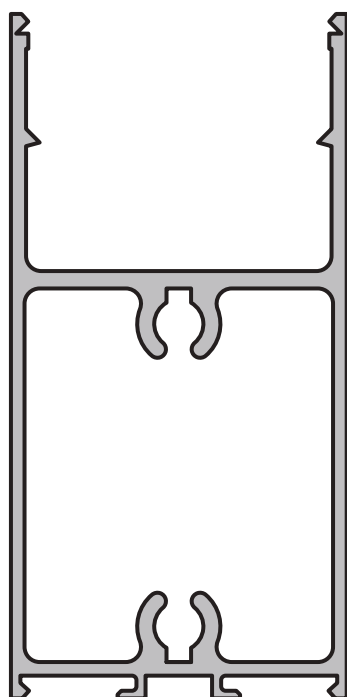

TRAVESAÑO HOJA

Perfil: 11
Peso: 1,671 Kg/m
Matriz: M0677



TAPACANTO

Perfil: 41
Peso: 0,232 Kg/m
Matriz: M0798

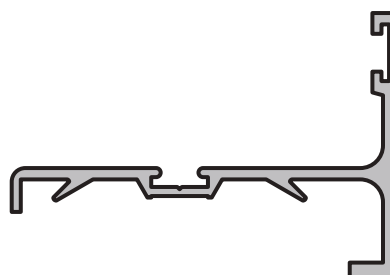

TAPACANTO CON TOPE PARA BATIENTE

Perfil: 42
Peso: 0,481 Kg/m
Matriz: M0799



TAPACANTO - PUERTA VAIVEN

Perfil: 40

Peso: 0,140 Kg/m

Matriz: M0797

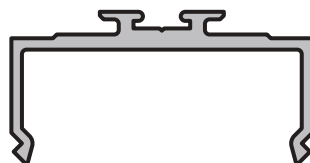

PORTA BURLETE Y PORTA CONTRAVIDRIO

Perfil: 23

Peso: 0,394 Kg/m

Matriz: M0692



CONTRAVIDRIO 8 mm

Perfil: 5596

Peso: 0,140 Kg/m



CONTRAVIDRIO 12 mm

Perfil: 5588

Peso: 0,146 Kg/m

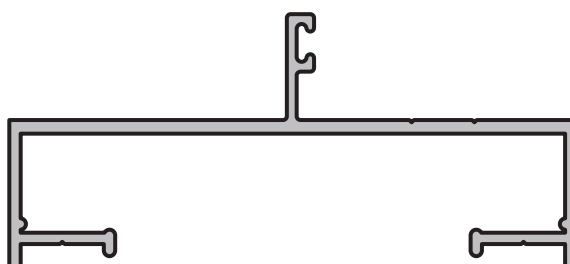

MARCO - PUERTA PLACA SIMPLE CONTACTO

Perfil: 681

Peso: 0,699 Kg/m

Matriz: M1724



REGULADOR 95 A 115 mm.

Perfil: 7020

Peso: 0,659 Kg/m



REGULADOR 115 A 135 mm.

Perfil: 7021

Peso: 0,791 Kg/m

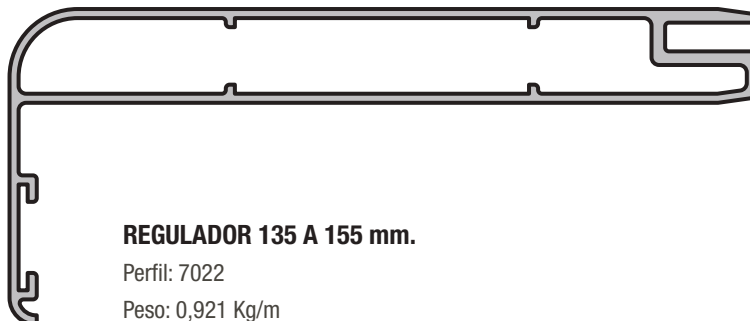

REGULADOR 135 A 155 mm.

Perfil: 7022

Peso: 0,921 Kg/m

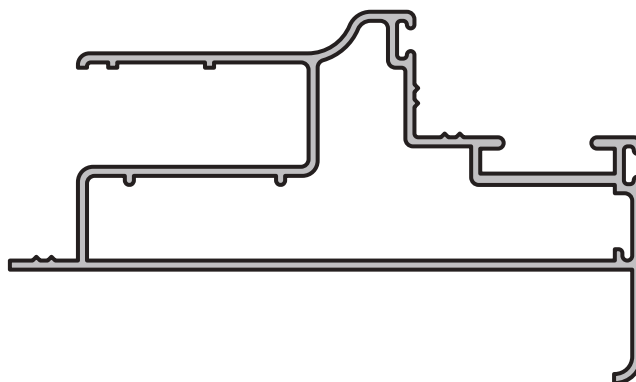

MARCO PUERTA PLACA

Perfil: 7023

Peso: 0,956 Kg/m

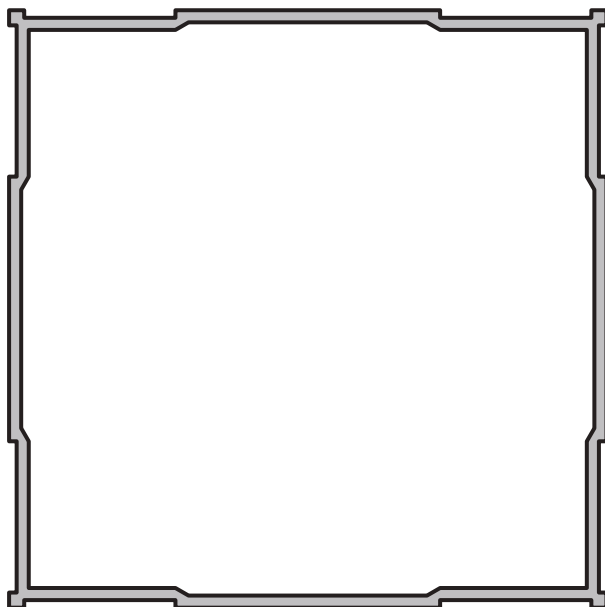

COLUMNA DE ACOUPLE

Perfil: 185

Peso: 1,350 Kg/m

Matriz: M2450

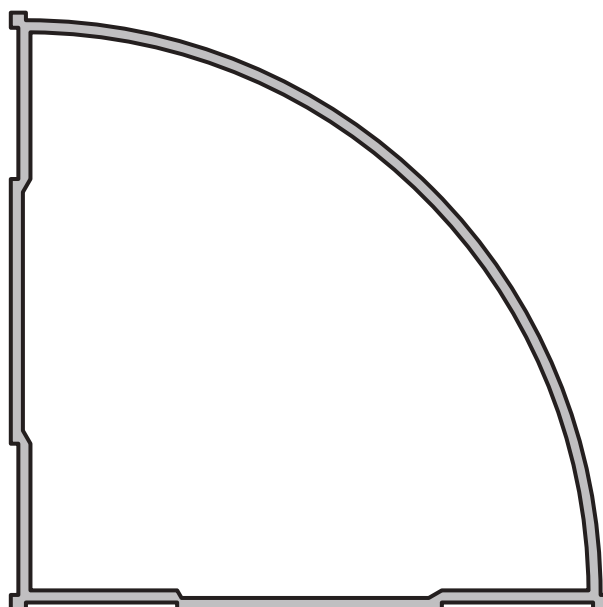

ACOPLE EN ESQUINA

Perfil: 186

Peso: 1,202 Kg/m

Matriz: M2457

Herrero / acoples

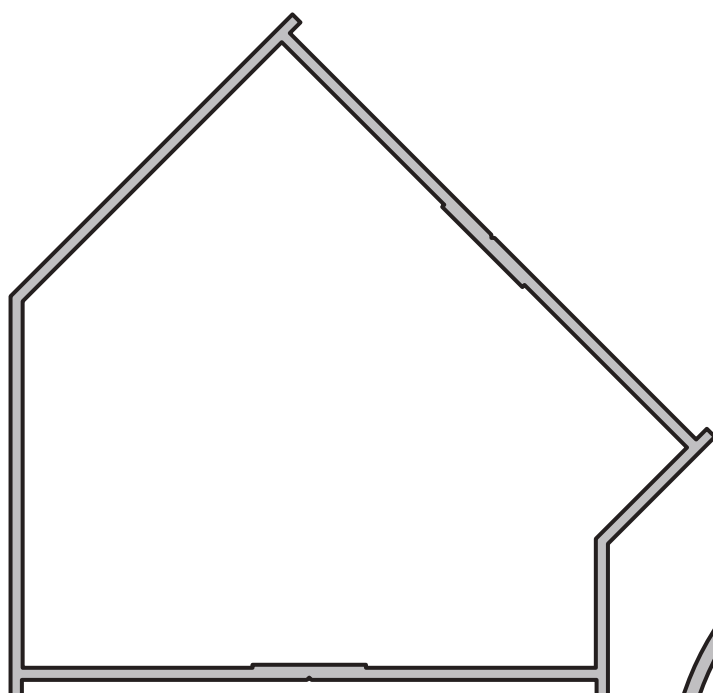

TUBO DE ACOPLE A 45

Perfil: 718

Peso: 1,320 Kg/m

Matriz: M2506

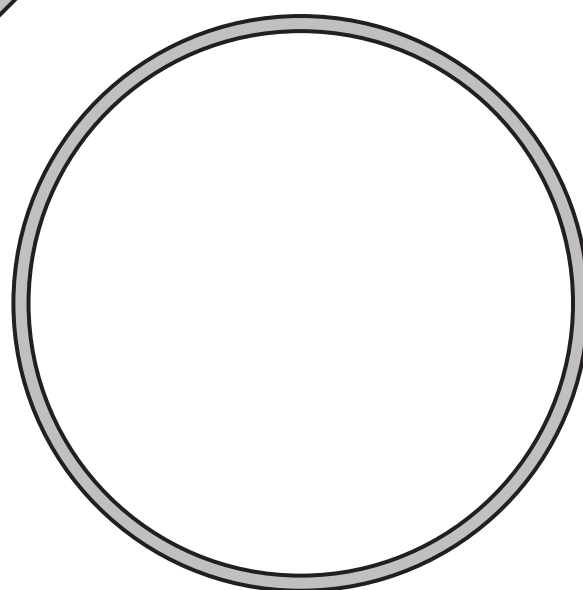

PERFIL DE ACOPLE 75 mm.

Perfil: 6569

Peso: 0,416 Kg/m

TUBO DIAMETRO 76 x 2 PARA ROTULA

Perfil: PC744

Peso: 1,240 Kg/m

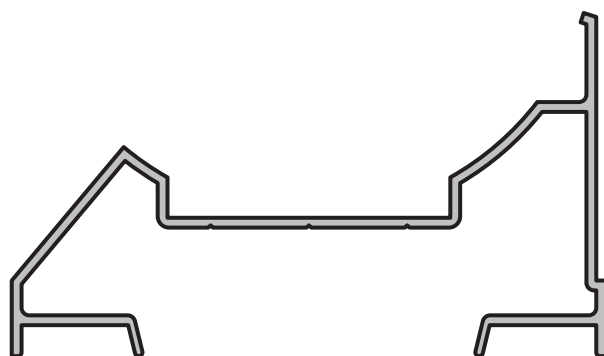

PERFIL ROTULA

Perfil: 187

Peso: 0,678 Kg/m

Matriz: M2461

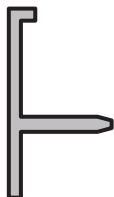

TAPA PARA PREMARCO UNIVERSAL

Perfil: 2501

Peso: 0,173 Kg/m

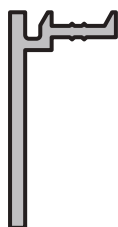

TAPAJUNTA

Perfil: 46

Peso: 0,224 Kg/m

Matriz: M0872

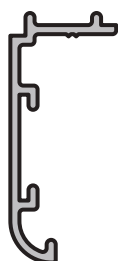

TAPAJUNTA CURVO

Perfil: 7149

Peso: 0,194 Kg/m



TAPAJUNTA JOTA

Perfil: M-0124

Peso: 0,172 Kg/m

Matriz: M0124



PREMARCO UNIVERSAL

Perfil: 2500

Peso: 0,988 Kg/m

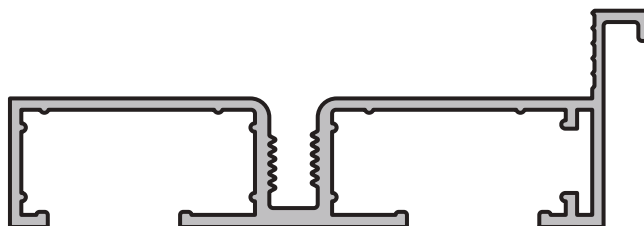

PREMARCO STANDARD

Perfil: 51

Peso: 0,883 Kg/m

Matriz: M0946



PREMARCO 80 mm

Perfil: 6901

Peso: 0,710 Kg/m

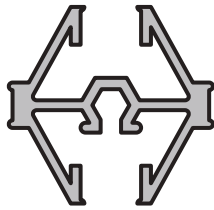

TRAVESAÑO VIDRIO REPARTIDO

Perfil: 801
Peso: 0,434 Kg/m
Matriz: M2775

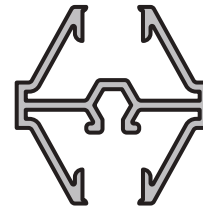

TRAVESAÑO VIDRIO REPARTIDO

Perfil: 6571
Peso: 0,359 Kg/m

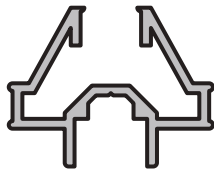

BASTIDOR VIDRIO REPARTIDO CORREDIZA

Perfil: 800
Peso: 0,305 Kg/m
Matriz: M2774

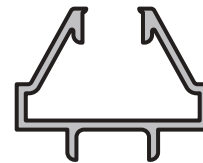

BASTIDOR VIDRIO REPARTIDO CORREDIZA

Perfil: 6572
Peso: 0,243 Kg/m

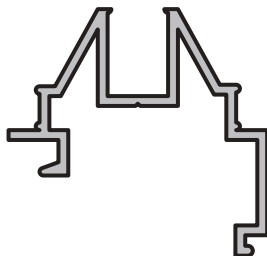

BASTIDOR VIDRIO REPARTIDO PAÑO FIJO

Perfil: 802
Peso: 0,389 Kg/m
Matriz: M2776

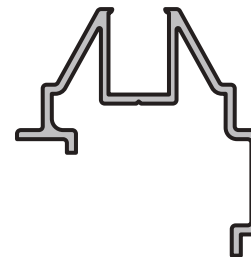

BASTIDOR VIDRIO REPARTIDO PAÑO FIJO

Perfil: 6765
Peso: 0,316 Kg/m

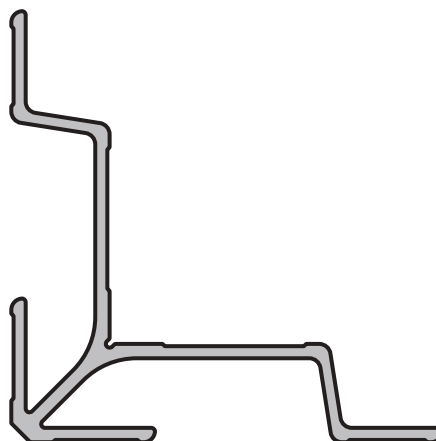

ESCUADRA DE ARMADO PARTE A B y C

Perfil: 37

Peso: 0,745 Kg/m

Matriz: M0642



MOSQUITERO CHICO

Perfil: 6

Peso: 0,199 Kg/m

Matriz: M0197

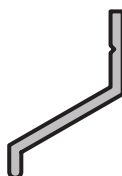

BOTA AGUA

Perfil: 5746

Peso: 0.124 Kg/m



RDO

Red de Distribuidores
Oficiales

RC©

Red de Carpinteros
Certificados

ALUAR ALUMINIO ARGENTINO SAIC

Administración: Pasteur 4600, B1644AMV, Victoria Buenos Aires
Argentina, Tel: +54 11 4725-8000

Sede Social: Marcelo T. de Alvear 590, piso 3°, C1058AAF C.A.B.A.

Argentina, Tel: +54 11 4313-7593 +54 11 4311-9026/5743

R.P.C. Nro. 2534, L° 72, F° 151, T° "A" de Est. Nac. 26/06/1970
asistenciatecnica@aluar.com.ar - www.aluarnews.com.ar

